

# marantz®

**Model CD7300 User Guide**

---

Compact Disc Player

CLASS 1 LASER PRODUCT  
LUOKAN 1 LASERLAITE  
KLASS 1 LASERAPPARAT



## ENGLISH

### **WARRANTY**

For warranty information, contact your local Marantz distributor.

### **RETAIN YOUR PURCHASE RECEIPT**

Your purchase receipt is your permanent record of a valuable purchase. It should be kept in a safe place to be referred to as necessary for insurance purposes or when corresponding with Marantz.

### **IMPORTANT**

When seeking warranty service, it is the responsibility of the consumer to establish proof and date of purchase. Your purchase receipt or invoice is adequate for such proof.

### **FOR U.K. ONLY**

This undertaking is in addition to a consumer's statutory rights and does not affect those rights in any way.

## FRANÇAIS

### **GARANTIE**

Pour des informations sur la garantie, contacter le distributeur local Marantz.

### **CONSERVER L'ATTESTATION D'ACHAT**

L'attestation d'achat est la preuve permanente d'un achat de valeur. La conserver en lieu sûr pour s'y reporter aux fins d'obtention d'une couverture d'assurance ou dans le cadre de correspondances avec Marantz.

### **IMPORTANT**

Pour l'obtention d'un service couvert par la garantie, il incombe au client d'établir la preuve de l'achat et d'en corroborer la date. Le reçu ou la facture constituent des preuves suffisantes.

## DEUTSCH

### **GARANTIE**

Bei Garantiefragen wenden Sie sich bitte an Ihren Marantz-Händler.

### **HEBEN SIE IHRE QUITTING GUT AUF**

Die Quittung dient Ihnen als bleibende Unterlage für Ihren wertvollen Einkauf. Das Aufbewahren der Quittung ist wichtig, da die darin enthaltenen Angaben für Versicherungswecke oder bei Korrespondenz mit Marantz angeführt werden müssen.

### **WICHTIG!**

Bei Garantiefragen muß der Kunde eine Kaufunterlage mit Kaufdatum vorlegen. Ihren Quittung oder Rechnung ist als Unterlage ausreichend.

## NEDERLANDS

### **GARANTIE**

Voor inlichtingen omtrent garantie dient u zich tot uw plaatselijke Marantz.

### **UW KWITANTIE, KASSABON E.D. BEWAREN**

Uw kwitantie, kassabon e.d. vormen uw bewijs van aankoop van een waardevol artikel en dienen op een veilige plaats bewaard te worden voor evt. verwijzing bijv. in verband met verzekering of bij correspondentie met Marantz.

### **BELANGRIJK**

Bij een evt. beroep op de garantie is het de verantwoordelijkheid van de consument een gedateerd bewijs van aankoop te tonen. Uw kassabon of factuur zijn voldoende bewijs.

## ESPAÑOL

### **GARANTIA**

Para obtener información acerca de la garantía póngase en contacto con su distribuidor Marantz.

### **GUARDE SU RECIBO DE COMPRA**

Su recibo de compra es su prueba permanente de haber adquirido un aparato de valor. Este recibo deberá guardarlo en un lugar seguro y utilizarlo como referencia cuando tenga que hacer uso del seguro o se ponga en contacto con Marantz.

### **IMPORTANTE**

Cuando solicite el servicio otorgado por la garantía el usuario tiene la responsabilidad de demostrar cuándo efectuó la compra. En este caso, su recibo de compra será la prueba apropiada.

## ITALIANO

### **GARANZIA**

L'apparecchio è coperto da una garanzia di buon funzionamento della durata di un anno, o del periodo previsto dalla legge, a partire dalla data di acquisto comprovata da un documento attestante il nominativo del Rivenditore e la data di vendita. La garanzia sarà prestata con la sostituzione o la riparazione gratuita delle parti difettose.

Non sono coperti da garanzia difetti derivanti da uso improprio, errata installazione, manutenzione effettuata da personale non autorizzato o, comunque, da circostanze che non possano riferirsi a difetti di funzionamento dell'apparecchio. Sono inoltre esclusi dalla garanzia gli interventi inerenti l'installazione e l'allacciamento agli impianti di alimentazione.

Gli apparecchi verranno riparati presso i nostri

Centri di Assistenza Autorizzati. Le spese ed i rischi di trasporto sono a carico del cliente.

La casa costruttrice declina ogni responsabilità per danni diretti o indiretti provocati dalla inosservanza delle prescrizioni di installazione, uso e manutenzione dettagliate nel presente manuale o per guasti dovuti ad uso continuato a fini professionali.

## PORTUGUÊS

### **GARANTIA**

Para informações sobre a garantia, contactar o distribuidor Marantz local.

### **GUARDAR O RECIBO DE COMPRA**

O recibo é o registo permanente da compra que fez. Deve ser guardado num local seguro, para ser apresentado em questões relacionadas com o seguro ou para quando tiver de contactar a Marantz.

### **IMPORTANTE**

Quando procurar assistência técnica ao abrigo da garantia, é da responsabilidade do consumidor estabelecer a prova e data de compra. O recibo é prova adequada.

## SVENSKA

### **GARANTI**

För information om garantin, kontakta Marantz lokalgagent.

### **SPAR KVITTOT**

Kvittot är ett inköpsbevis på en värdefull vara. Det skall förvaras säkert och hänvisas till vid försäkringsfall eller vidkorrespondens med Marantz.

### **VIKTIGT**

Fö att garantin skall gälla är det kundens sak att framställa bevis och datum om köpet. Kvitto eller faktura är tillräckligt bevis för detta.

## DANSK

### **GARANTI**

Henvend dem til Deres MARANTZ-forhandler angående information om garantien.

### **GEM DERES KVITTERING**

Deres købskvittering er Deres varige bevis på et dyrt køb. Den bør gemmes godt og anvendes som bevis, hvis De vil tegne en forsikring, eller hvis De kommunikerer med Marantz.

### **VIGTIGT**

Det påhviler forbrugeren at skaffe bevis for købet og købsdatoen, hvis han eller hun ønsker garantiservice. Deres købskvittering eller faktura er et fulgyldigt bevis herpå.

## FOREWORD

This section must be read before any connection is made to the mains supply.

### WARNINGS

- Do not expose the equipment to rain or moisture.
- Do not remove the cover from the equipment.
- Do not insert anything into the equipment through the ventilation holes.
- Do not handle the mains lead with wet hands.
- Do not cover the ventilation with any items such as tablecloths, newspapers, curtains, etc.
- No naked flame sources, such as lighted candles, should be placed on the equipment.
- When disposing of used batteries, please comply with governmental regulations or environmental public instruction's rules that apply in your country or area.

## CE marking

**CE** The CD7300 conforms with the EMC directive and low-voltage directive.

## EQUIPMENT MAINS WORKING SETTING

Your Marantz product complies with the household power and safety requirements in your area. This product can be powered by 230 V AC only.

## COPYRIGHT

Recording and playback of any material may require consent. For further information refer to the following:

- Copyright Act 1956
- Dramatic and Musical Performers Act 1958
- Performers Protection Acts 1963 and 1972
- any subsequent statutory enactments and orders

## INTRODUCTION

Thank you for selecting the Marantz CD7300 CD Player for your A / V system.

This Compact Disc Player incorporates a number of features designed to enhance the listening of your favorite audio sources.

Please read these operating instructions carefully. We recommend that you read the entire user guide before you attempt to connect or operate the player. After you have reviewed the contents of this manual, we suggest that you make all system connections before you attempt to operate the unit.

## INSTALLATION

Remember the following important points when installing the player:

- Do not expose the player to rain or moisture, as this may cause damage to the player.
- All players produce some heat during operation and this heat must be allowed to disperse freely. Do not close any ventilation openings and insure that there is adequate ventilation space behind, beside and above the player.
- Prevent extra heat from reaching the unit. Never put the player in the full glare of the sun or near a heat source.

## PRECAUTIONS

The following precautions should be taken when operating the equipment.

## GENERAL PRECAUTIONS

When installing the equipment ensure that:

- the ventilation holes are not covered.
- air is allowed to circulate freely around the equipment.
- it is placed on a vibration-free surface.
- it will not be exposed to excessive heat, cold, moisture or dust.
- it will not be exposed to direct sunlight.
- it will not be exposed to electrostatic discharges.

In addition, never place heavy objects on the equipment.

If a foreign object or water does enter the equipment, contact your nearest dealer or service center.

Do not pull out the plug by pulling on the mains lead; grasp the plug.

It is advisable when leaving the house for an extended period, or during a thunderstorm, to disconnect the equipment from the mains supply.

## PRECAUTIONS IN CONNECTION

- Be sure to unplug the power cable from the AC outlet or turn off the POWER switch before proceeding with any connection.
- Connect one cable at a time observing the "input" and "output". This will avoid any cross connection between channels and signal inputs and outputs.
- Insert the plugs securely. Incomplete connection may result in noise.
- Prior to connecting other audio and video equipment to the CD7300, please read their owner's manuals.

## CONTENTS

<b>BEFORE USING .....</b>	<b>2</b>
NOTES ABOUT THE DISCS .....	2
INAPPROPRIATE PLACES FOR INSTALLATION .....	2
ABOUT PLAYING COPY-CONTROLLED CDS .....	2
DO NOT PLACE OBJECTS ON TOP .....	2
CAUTIONS ON HANDLING POWER CORD .....	2
DO NOT ATTEMPT REPAIRS YOURSELF .....	2
PRECAUTIONS .....	2
CAUTIONS ON HANDLING BATTERIES .....	2
<b>ACCESSORIES .....</b>	<b>3</b>
CHECKING THE ACCESSORIES .....	3
USAGE OF REMOTE CONTROL UNIT .....	3
<b>FEATURES .....</b>	<b>4</b>
<b>CONNECTIONS .....</b>	<b>5</b>
CONNECTING TO AN AMPLIFIER .....	5
CONNECTING TO A DIGITAL AUDIO COMPONENT .....	5
<b>NAMES AND FUNCTIONS .....</b>	<b>6</b>
FRONT PANEL .....	6
DISPLAY .....	7
REMOTE CONTROL UNIT .....	8
REAR PANEL .....	9
<b>BASIC OPERATIONS .....</b>	<b>10</b>
PLAYING CDS .....	10
PLAYING A SPECIFIC TRACK .....	10
PLAYING A SPECIFIC PART OF A SPECIFIC TRACK .....	11
<b>ADVANCED OPERATIONS .....</b>	<b>12</b>
REPEAT PLAY (PLAYING THE SAME TRACKS REPEATEDLY) .....	12
RANDOM PLAY (PLAYING TRACKS IN A RANDOM SEQUENCE) .....	12
AMS PLAY (SEARCHING FOR A SPECIFIC TRACK) .....	13
PROGRAM PLAY (PLAYING TRACKS IN THE PREFERRED SEQUENCE) .....	13
DELETE PROGRAM PLAY (PLAY WITH UNDESIRE TRACKS SKIPPED) .....	14
PITCH CONTROL (CHANGING THE PLAY SPEED) .....	16
<b>SETTING THE PLAY FUNCTIONS ....</b>	<b>17</b>
USING EASY JOG .....	17
VARIOUS PLAY FUNCTIONS (PLAY MODES) ..	17
<b>OTHER FUNCTIONS .....</b>	<b>20</b>
LAST MEMORY .....	20
CD-TEXT .....	20
CR-R/CD-RW DISC PLAY .....	20
MP3 .....	21
<b>SPECIFICATIONS AND DIMENSIONS ....</b>	<b>22</b>
SPECIFICATIONS .....	22
DIMENSIONS (UNIT: MM) .....	22
<b>TROUBLESHOOTING .....</b>	<b>22</b>

# BEFORE USING

## NOTES ABOUT THE DISCS

\* **Handle the discs carefully so as not to scratch their surfaces.**

\* **Keep the surfaces of the discs clean at all times.**

When cleaning the surfaces of discs, always be sure to use the special cleaner and wipe the surfaces in the directions shown in the figure below.

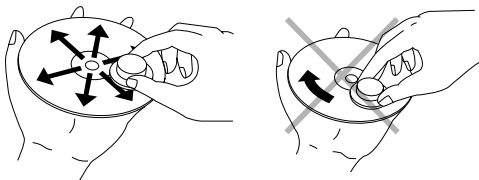

- Wipe the surface radially from the center.
- Do not wipe the surface in the circumferential direction.

\* **Do not attach pieces of paper or stickers to the label surfaces of the discs.**

When a disc has a piece of plastic tape or rental CD label with paste protruding from the edge or when a disc still bears traces of sticky tape or adhesive labels, do not attempt to play it. If such a disc is played on the CD player, you may find that you cannot remove it or that some other kind of malfunctioning may occur.

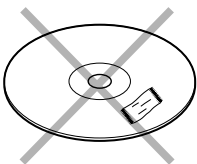

\* **Do not use discs which come in special shapes.**

Do not attempt to play heart-shaped or octagonal discs or discs with any other special shapes. You may find that you cannot remove them or that some other kind of malfunctioning may occur in the player.

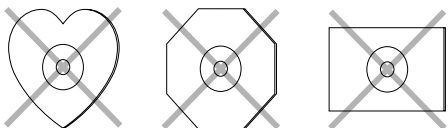

\* **Use discs which satisfy the CD standards such as those with the "CD logo", "CD-TEXT" or "CD-TEXT" mark on their disc label surfaces.**

No guarantees are made for playback if discs which do not satisfy the appropriate CD standards are used.

Similarly, no guarantees are made for their sound quality even if it is possible to play such discs.

\* **To protect your discs from damage, avoid placing them in the following locations.**

- Where they will be exposed to direct sunlight or where they will be close to a heater or other heat-radiating appliance
- Where the humidity level is high or it is very dusty
- Near a window or other such location where they may be exposed to rain

\* **Get into the habit of putting the discs back in their cases after use.**

## INAPPROPRIATE PLACES FOR INSTALLATION

To keep your player in perfect working order for the longest possible time, avoid installing the player in the following locations.

- Wherever it will be exposed to direct sunlight
- Wherever it will be close to a heater or other heat-radiating appliance
- Wherever the humidity is high or ventilation is poor
- Wherever it is very dusty
- Wherever it will be subject to vibration
- On top of a rickety stand or in an unstable location which is tilted at an angle
- On top of an amplifier or other component which dissipates a great deal of heat
- In an audio rack with little space at the top and bottom or other location where the heat dissipation will be obstructed

To ensure proper heat dissipation, install the player while leaving clearances between the player and wall or other components, as shown in the figure below.

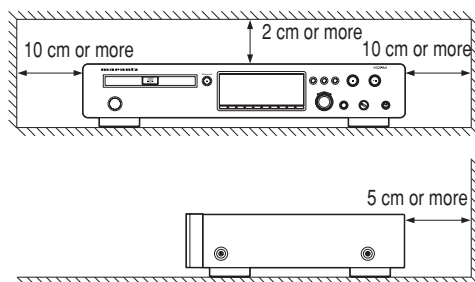

## ABOUT PLAYING COPY-CONTROLLED CDS

- Some copy-controlled CDs may not conform to official CD standards. They are special discs and may not play on the CD7300.

## DO NOT PLACE OBJECTS ON TOP

- Refrain from placing any objects on top of the player.

## CAUTIONS ON HANDLING POWER CORD

- Do not touch the power cord with wet hands.
- When disconnecting the power cord, always make sure that you take hold of the plug. Yanking out or bending the cord can damage it and/or cause electric shocks or a fire.
- Get into the habit of disconnecting the power plug before leaving home.

## DO NOT ATTEMPT REPAIRS YOURSELF

- Refrain from lubricating the player: doing so can cause malfunctioning.
- Only qualified engineers with specialized expertise are authorized to repair the pick-up and parts inside the player.

## PRECAUTIONS

- In winter, droplets of water form on the insides of the windows of a heated room: this is called condensation. This CD player uses an optical lens, so the condensation may form in the following cases.
  - In a room immediately after the heating has been turned on
  - In a room where the humidity level is high
  - When the player has been suddenly brought from a cold location into a warm room

Since, in cases like this, the track numbers may not be read and the player is prevented from operating properly, wait about 30 minutes, and then operate the player.

- This player may cause interference on a tuner or TV set. If this is the case, place it further away from the tuner or TV set.
- Compact discs have much less noise than analog records and hardly any noise is heard before play starts. Bear in mind, therefore, that if the volume control on the amplifier is set too high, you will risk damaging other audio components.
- This player is designed to play music CDs only. It cannot play CD-ROMs used with personal computers, game CDs, video CDs or DVDs (video/audio).

## CAUTIONS ON HANDLING BATTERIES

Misuse of the batteries can result in electrolyte leakage, rupturing, corrosion, etc.

Bear in mind the following points when using batteries.

- Remove the batteries from the remote control unit if the unit is not going to be used for a prolonged period (a month or more).
- Do not use an old battery together with a new one.
- Insert the batteries while ensuring that their  $\oplus$  and  $\ominus$  poles are properly aligned with the corresponding markings on the remote control unit.
- Batteries with the same shape may have different voltages. Do not use different types of batteries together.
- If electrolyte has leaked, thoroughly wipe the inside of the battery compartment, and then insert new batteries.

# ACCESSORIES

## CHECKING THE ACCESSORIES

After opening the cover of the packing box, check that the following accessories are included.

- Remote control unit (RC7300CD)

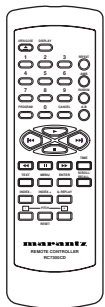

- Size "AA" batteries x 2

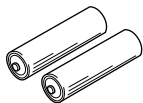

- Audio connecting cord (1 meter long)

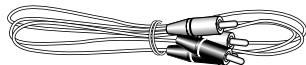

- Remote control connecting cord (90 cm long)

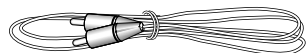

- User Guide
- Warranty card

## USAGE OF REMOTE CONTROL UNIT

### PRECAUTIONS

- Do not allow direct sunlight, an inverter fluorescent light or other strong source of light to shine onto the player's infrared signal reception window (remote sensor). Otherwise, the operation of the remote control unit may be disabled.
- Bear in mind that operating the remote control unit may cause other devices operated by infrared rays to be operated by mistake.
- The remote control unit cannot be operated if the space between the controller and the player's remote sensor is obstructed.
- Do not place any objects on top of the remote control unit. Doing so may cause one or more buttons to be held down which will cause the batteries to run down.

### OPERATIONAL RANGE

As shown in the figure below, the player can be operated by the remote control unit in a range which of about 5 meters from the player's remote sensor and over an angle up to 30 degrees to the left and 30 degrees to the right of the position directly in front.

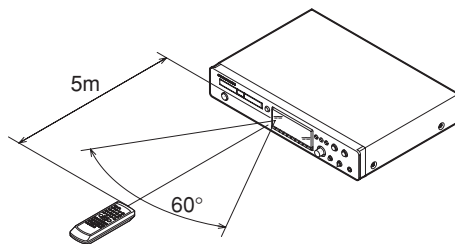

## LOADING BATTERIES

Before using the supplied remote control unit for the first time, load the batteries in the remote control unit. The batteries provided are used to verify the operations of the remote control unit only.

- 1 Take hold of the tab on the battery cover which is found on the back side of the remote control unit, and pull it up.

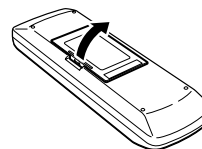

- 2 Load the two new size "AA" batteries inside the battery compartment while taking care to align their polarities correctly with the polarity markings (+ with + and - with -).

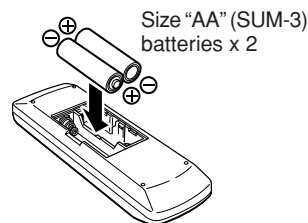

- 3 Push the battery cover down in the direction of the arrow to close it.

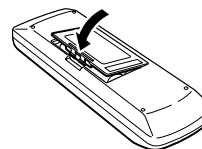

## FEATURES

- **Marantz's unique high-density voltage amplifier module HDAM® circuit featured**

This player features Marantz's same unique HDAM® (high-density voltage amplifier module) circuit which is incorporated into the model SA-12S1 SACD multi-channel player in its audio output circuit. The circuit achieves a high signal processing speed and wide band as a result, ensuring playback with a high sound quality.

- **CS4396 high-performance D/A converter made by Cirrus Logic used**

The CS4396 D/A converter whose CD playback circuitry has the same design as the CS4397 D/A converter, which was also made by Cirrus Logic and which has proved to be a valuable asset for the Marantz model SA8260 SACD player, has been adopted.

During CD play, the PCM signals recorded on the disc are oversampled to 128fs inside the D/A converter and then processed by a combination of the dynamic element matching (DEM) and multi-element switched capacitors to achieve playback characterized by a high linearity.

This new CD playback technology opens the door to new dimensions in high-sound-quality CD play.

- **Separate configuration of digital and analog parts**

The digital part consisting of the servo, decoder and microcomputer circuitry is packed onto the CD mechanism board where it is separated from the analog (audio circuitry) part.

This configuration shuts out the pulsive noise generated from the digital part and helps to yield pure music playback.

- **Display OFF function incorporated**

The "display OFF" function enables the main unit display to be turned off. By turning off this display, the pulsive noise generated from the display is reduced, thus eliminating its effects on the music signals.

- **Double-layer chassis construction using a 2.0 mm thick steel plate (weighing 1.5 kg) at the bottom**

Endowing the bottom panel (bottom chassis) with a double-layer construction yields a vibration-damping structure that diminishes the effects of both the rotational vibrations of the discs and external vibrations.

- **Playback of unfinalized CD-R/CD-RW discs supported**

The CD7300 can play even the CD-R and CD-RW discs on which information can still be recorded—something that conventional CD players could not do.

Since this player can play unfinalized discs which have some remaining recording time, partially edited discs can be played as well.

- **MP3 file play and display of text information (ID3 tag) supported**

This player supports CD-R/CD-RW discs with MP3 file recordings. It also supports the text information (ID3 tag) of the MP3 files so that track information, the names of the artists and other text information can be displayed. (Text cannot be displayed in Japanese.)

- **Pitch control function**

The "pitch control" function enables the play speed (pitch) to be varied over a  $\pm 12\%$  range. This feature is particularly useful for musical instrument practice sessions.

- **Quick replay function**

By a single-action operation, the "quick replay" function enables play to be moved back from the current play position for the time equivalent to the setting (setting range: 1 to 30 seconds) and play to be resumed.

This function makes it possible to return to a part of the track that was just played so it can be heard again.

- **EASY JOG control function**

This player comes with an EASY JOG control which has become such a familiar function with media such as MDs. Using this control together with the numeric buttons (0 to 9) on the front panel enables tracks to be located speedily and various playback functions to be set conveniently.

- **CD-TEXT display supported**

- **Timer play supported**

- **VAM2202 dedicated audio mechanism made by Philips featured**



# CONNECTIONS

This CD player is connected to an amplifier, CD recorder and other components for use. To ensure that the components are connected properly, refer to the instruction manuals that come with the components to be connected. Before connecting the components, be absolutely sure to turn off their power.

## CONNECTING TO AN AMPLIFIER

Use the audio connecting cord to connect the player with a stereo amplifier or AV amplifier. Do not connect the player to the PHONO input connectors on the amplifier. When making the connections, insert the plugs securely into the connectors. Failure to insert the plugs securely may result in noise.

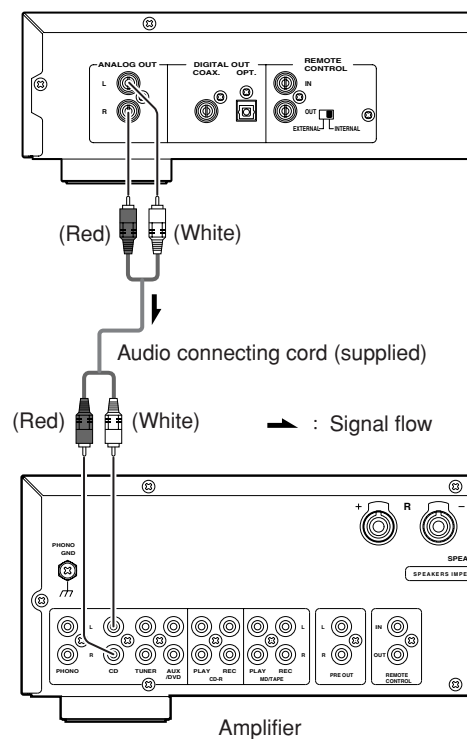

## CONNECTING TO A DIGITAL AUDIO COMPONENT

The player has one digital optical output connector and one digital coaxial output connector. You can enjoy digital recording when the player is connected to a CD recorder or other digital recording component.

## CONNECTING THE OPTICAL OUTPUT CONNECTOR

Use an optical digital connecting cable available on the market. Insert the plug firmly in until it clicks into place. Do not bend or bundle the optical digital connecting cable.

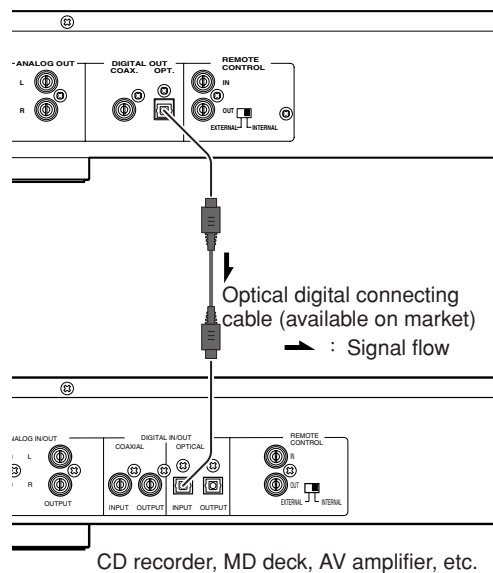

## CONNECTING THE COAXIAL OUTPUT CONNECTOR

Use a coaxial digital connecting cable available on the market.

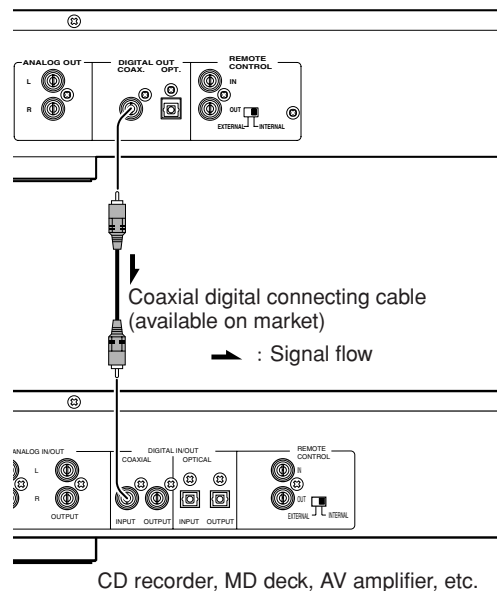

# NAMES AND FUNCTIONS

## FRONT PANEL

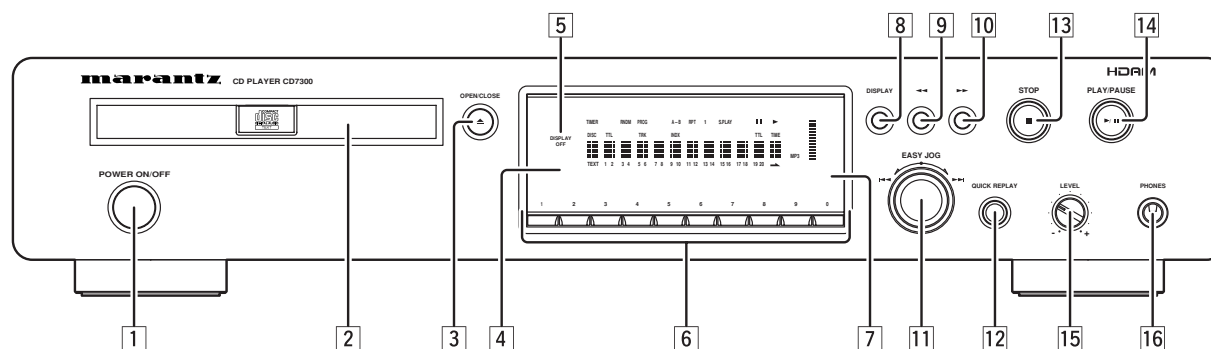

### 1 POWER ON/OFF switch

This is used to turn the player's power ON and OFF. When it is pressed, the display lights and the power is turned on; when it is pressed again, the power is turned off.

### 2 Disc tray

This is where the CD to be played is placed.

### 3 OPEN/CLOSE ▲ button

This is used to open and close the disc tray. When it is pressed, the disc tray opens; when it is pressed again, it closes.

### 4 Remote sensor

This senses the infrared control signals sent from the remote control unit.

### 5 DISPLAY OFF indicator

This lights in the DISPLAY OFF mode (when the display is off).

### 6 Numeric buttons (0 to 9)

These are used to specify the numbers of the tracks to be played.

### 7 Display

This shows the settings, play status, text information, etc.

### 8 DISPLAY button

This is used to turn off the display (DISPLAY OFF mode).

When it is pressed, the display is turned off; when it is pressed again, the display comes on.

### 9 ◀◀ (search backward) button

This is used to search backward during play. It also serves as the album selector button when playing discs with MP3 files recorded on them.

### 10 ▶▶ (search forward) button

This is used to search forward during play. It also serves as the album selector button when playing discs with MP3 files recorded on them.

### 11 EASY JOG/push enter button

Preceding or subsequent tracks can be searched (tracks can be skipped) by turning the jog dial clockwise or counterclockwise. In addition, the play functions (play modes) can be set using the jog dial.

### 12 QUICK REPLAY button

This is used to search backward from the current play position for the time equivalent to the setting and resume play.

### 13 STOP ■ button

This is used to stop play.

### 14 PLAY/PAUSE ▶/|| button

This is used to start play or temporarily suspend play.

### 15 PHONES LEVEL control

This is used to adjust the headphones volume level. The level increases when it is turned clockwise.

### 16 PHONES jack

The headphones are connected to this jack. Use headphones that come with a standard plug.



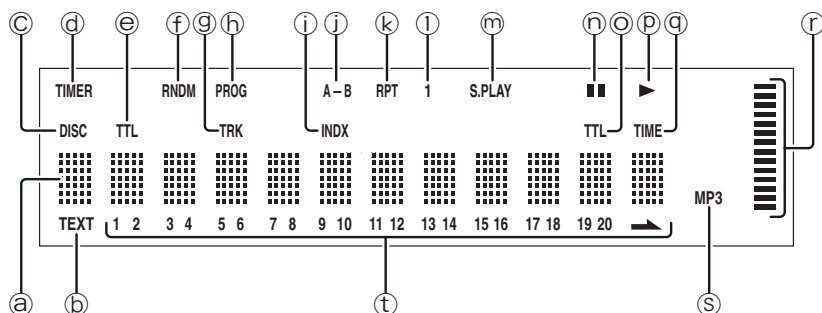

**A Main display**

This displays the time information and text information of the disc played, the setting menus, etc.

**B TEXT indicator**

This lights when a disc supporting CD-TEXT has been loaded.

**C DISC indicator**

This flashes during readout of the table of contents (TOC) information on the disc.

**D TIMER indicator**

This lights when timer play has been set.

**E TTL (total track) indicator**

This lights above the display of the total number of tracks recorded on the disc.

**F RNDM (random) indicator**

This lights during random play.

**G TRK (track) indicator**

This lights above the display of the number of the track being played, etc.

**H PROG (program) indicator**

This lights during program play.

**I INDX (index) indicator**

This lights above the display of the index number being played, etc.

**J A-B (A-B repeat) indicator**

This lights during A-B repeat play.

**K RPT (repeat) indicator**

This lights during repeat play.

**L 1 (1-track repeat) indicator**

This lights during 1-track repeat play.

**M S.PLAY (single track play) indicator**

This lights during single track play.

**N || (pause) indicator**

This lights when play is temporarily suspended.

**Q TIME indicator**

When the total remaining time or total program time is displayed, this lights above that display.

**P ► (play) indicator**

This lights during play.

**R TIME indicator**

This lights while the elapsed time or other such time is displayed.

**R Pitch control indicator**

This displays the pitch control setting.

**S MP3 indicator**

This lights when a disc on which MP3 files have been recorded is loaded.

**T 1 - 20, ► (music calendar)**

This displays the track numbers recorded on the disc, the track numbers still to be played, and the track numbers programmed for program play. During MP3 file play, the album is displayed.

## REMOTE CONTROL UNIT

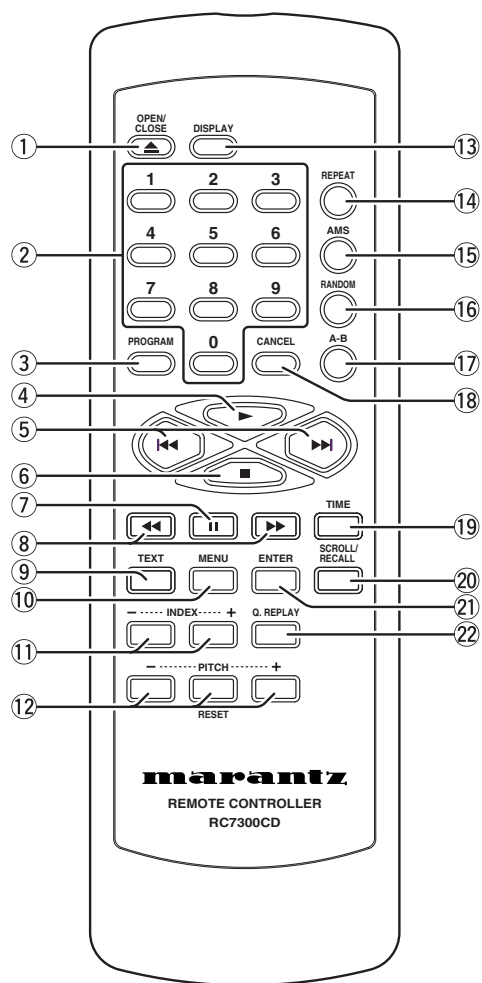
**① OPEN/CLOSE ▲ button**

This is used to open and close the disc tray. When it is pressed, the disc tray opens; when it is pressed again, it closes.

**② Numeric buttons (0 to 9)**

These are used to specify the numbers of the tracks to be played.

**③ PROGRAM button**

This is pressed to initiate program play.

**④ ► (play) button**

This is used to start play.

**⑤ ◀▶ (track skip) buttons**

◀▶ : Use this to return to the start of the track now playing or return to the start of the previous track.

▶▶ : Use this to advance to the start of the subsequent track.

**⑥ ■ (stop) button**

This is used to stop the play.

**⑦ || (pause) button**

This is used to temporarily suspend play.

**⑧ ◀▶ (search) buttons**

◀◀ : This button is used to search backward when it is held down during play.

▶▶ : This button is used to search forward when it is held down during play.

These buttons also serve as the album selector buttons when playing discs with MP3 files recorded on them.

**⑨ TEXT button**

This is used to switch the main display from the time display to the text display.

**⑩ MENU button**

This is used to switch to the play function (play mode) setting menu.

**⑪ INDEX +/- (index down/up) buttons**

These are used to skip and search indexes. They can be used with discs on which index numbers have been recorded.

**⑫ PITCH -/RESET/+ (pitch control down/reset/up) buttons**

These are used to adjust the play speed (pitch) with a  $\pm 12\%$  range.

**⑬ DISPLAY button**

This is used to turn off the display (DISPLAY OFF mode).

**⑭ REPEAT button**

This is used to play one track or all the tracks on the disc repeatedly.

**⑮ AMS (auto music scan) button**

This is used to play the intros of all the tracks in sequence starting from the first track for the duration equivalent to the setting.

**⑯ RANDOM button**

This is used to play the tracks in a random sequence.

**⑰ A-B (A-B repeat) button**

This is used to set start point (A) and end point (B) when a particular section is to be played repeatedly.

**⑱ CANCEL button**

This is used to cancel the programmed tracks.

**⑲ TIME button**

This switches the main display from the text display to the time display. It can also switch the time display during play.

It can display how much time has elapsed and how much play time remains for the current track as well as how much play time remains for the whole disc. During MP3 file play, it displays the elapsed time only.

**⑳ SCROLL/RECALL button**

This is used to scroll the text display when text is displayed. When it is pressed during program play, it is possible to check which tracks have been programmed.

**㉑ ENTER button**

This is used to enter the play function settings.

**㉒ Q.REPLAY (quick replay) button**

This is used to search backward from the current play position for the time equivalent to the setting and resume play.

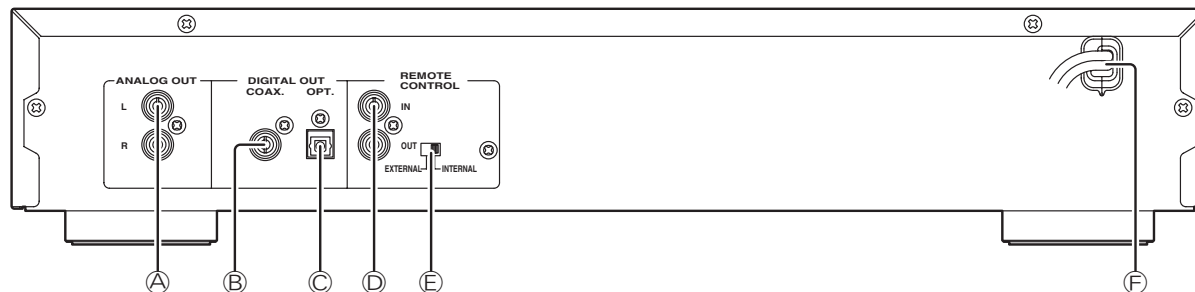

**A ANALOG OUT (analog output) connectors**  
The music signals during play are output from these connectors.

**B DIGITAL OUT COAX. (digital coaxial output) connector**  
The music signals during play are output digitally from this coaxial output connector.  
\* Digital signals are not output during MP3 file play or pitch control play.

**C DIGITAL OUT OPT. (digital optical output) connector**  
The music signals during play are output digitally from this optical output connector.  
\* Digital signals are not output during MP3 file play or pitch control play.

**D REMOTE CONTROL IN and OUT connectors**  
Using the supplied remote control connecting cable, these connectors enable this player to be connected to a Marantz component equipped with remote control connectors. These connections make it possible to control an entire system that centers on the amplifier or other such component.

**E EXTERNAL/INTERNAL switch**  
Before the player was shipped from the factory, this switch was set to INTERNAL to enable the remote sensor built into the player to be used. Before using the supplied connecting cable to make the connection between the player and the remote control connectors on a Marantz equipment, set the switch to EXTERNAL.

**Note:**  
\* Signals cannot be received from the remote control unit if the switch is kept at EXTERNAL when the player is to be used on its own.

**F AC POWER SOURCE CONNECTION**  
With the POWER switch set to the OFF position, plug the mains lead into a mains outlet providing the right voltage.

# BASIC OPERATIONS

## PLAYING CDS

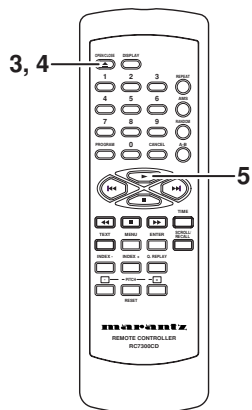
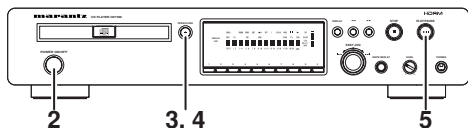

1. Turn on the power of the amplifier to which the player is connected, and use the input selector on the amplifier to select "CD" (the player's input source which has been connected).
2. Press the POWER button on the player to turn on the power.
3. Press the OPEN/CLOSE ▲ button on the player or remote control unit. Place the CD to be played in the extended disc tray while ensuring that the label with the printed text is facing up.

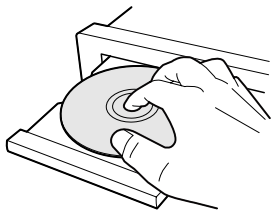

In the case of a single (8 cm) CD, align it with the indentation in the center of the tray.

4. Press the OPEN/CLOSE ▲ button on the player or remote control unit to retract the disc tray. Pushing the front of the disc tray lightly also causes the tray to be retracted. Once the disc tray has been retracted, "TOC Reading" appears on the display, after which the total number of CD tracks and total remaining time are displayed. In the case of a disc that supports CD-TEXT, the album title is displayed, and then the total number of CD tracks and total remaining time are displayed.

5. Press the ►/|| button on the player or ► button on the remote control unit to start play. Adjust the volume level at the amplifier.

### STOPPING PLAY

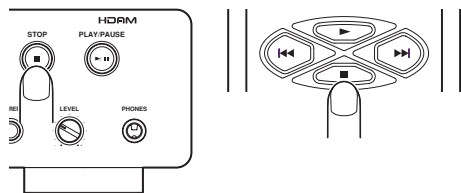

Press the ■ button on the player or remote control unit during play.

### PAUSING PLAY

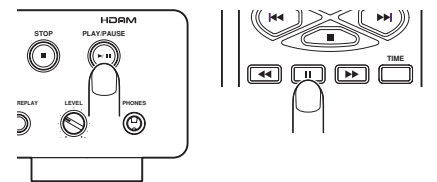

During play, press the ►/|| button on the player or || button on the remote control unit to temporarily suspend play. To resume play from the place where it was temporarily suspended, press the ►/|| button on the player or the ► button or || button on the remote control unit.

### REMOVING THE CD

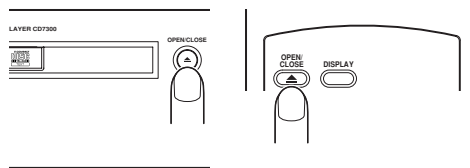

After play has finished, press the OPEN/CLOSE ▲ button on the player or remote control unit to extend the disc tray, and remove the CD. After the CD has been removed, press the OPEN/CLOSE ▲ button again to retract the disc tray. The disc tray should always be retracted when the player is not in use.

### PLAYING A SPECIFIC TRACK

#### SPECIFYING THE NUMBER OF A TRACK TO BE PLAYED (DIRECT SEARCH)

Select the number of the track to be played directly by pressing the numeric buttons (0 to 9) on the player or remote control unit.

To select track number 10 or above, use the numeric buttons to select the higher digit first and then select the lower digit.

Once the number of the track is selected, play will start automatically.

**Example: To play track 3**  
Press the "3" numeric button.

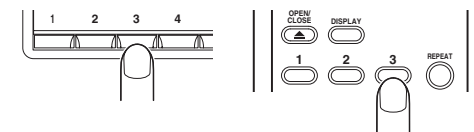

**Example: To play track 12**  
Press the "1" numeric button.

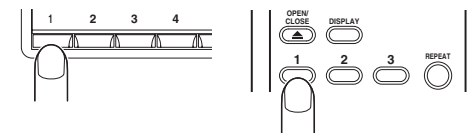

Within 1 second, press the "2" numeric button.

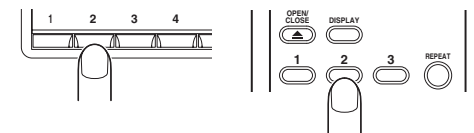

**Note:**

\* If a disc recorded with MP3 files also contains some data files which are not MP3 files, the track before or after the number of the selected track may be played. Direct search is supported only for the album being played.

## PLAYING A PREVIOUS OR SUBSEQUENT TRACK (TRACK SKIP)

### Advancing to a subsequent track

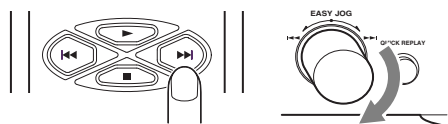

Press the ►► button on the remote control unit for the number of times equivalent to the number of tracks through which play is to be advanced. Play can also be advanced to the tracks ahead by turning EASY JOG on the player clockwise. When EASY JOG is no longer turned in the stop mode, the selected track is played after one second elapses.

### Returning to the start of the track now playing or a previous track



When the ◀◀ button on the remote control unit is pressed, play returns to the start of the track now playing. Play returns to the previous track which is equivalent to the number of times the button was pressed.

In the same way, play can also be returned to the start of the track now playing by turning EASY JOG dial on the player counterclockwise. If it is turned further, play will return to the previous track which is equivalent to the amount by which the dial was turned.

When EASY JOG is no longer turned in the stop mode, the selected track is played after one second elapses.

**Note:**

\* If a disc recorded with MP3 files also contains some data files which are not MP3 files, the track before or after the number of the selected track may be played.

## PLAYING A SPECIFIC PART OF A SPECIFIC TRACK

### USING THE INDEX FUNCTION (INDEX SKIP)

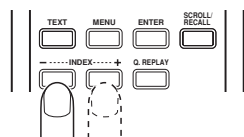

An index search can be performed during the play of a track whose index has been recorded.

This function is useful for starting play at a specific location of a long track. It returns play to a previous index which is equivalent to the number of times the INDEX- button on the remote control unit was pressed; alternatively, it advances play to a subsequent index which is equivalent to the number of times the INDEX+ button on the remote control unit was pressed.

If the index skip function is operated for a CD with no indexes recorded, the "No Index" message appears on the main display, and play returns to the start of the track now playing.

**Note:**

\* The index skip function cannot be used for discs recorded with MP3 files.

### SEARCHING A SPECIFIC PART OF A TRACK (SEARCH)

While listening to a track being played, it is possible to search a specific part of that track by a forward or backward search.

### Forward searching through the track now playing

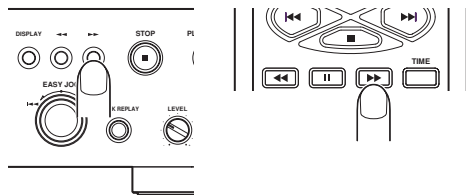

The search (forward search) mode is established by holding down the ►► button on the player or remote control unit.

During MP3 file play, play advances to the album title which is equivalent to the number of times the button has been pressed. Holding down the button initiates a forward search.

### Backward searching through the track now playing

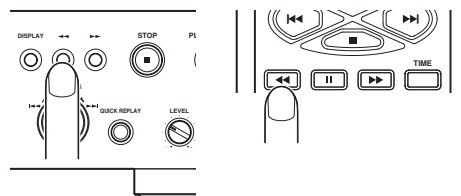

The search (backward search) mode is established by holding down the ◀◀ button on the player or remote control unit.

During MP3 file play, play returns to the album title which is equivalent to the number of times the button has been pressed. Holding down the button initiates a backward search. (Returns during backward searches are not constant.)

### PLAYING THE LAST FEW SECONDS AGAIN DURING PLAY (QUICK REPLAY)

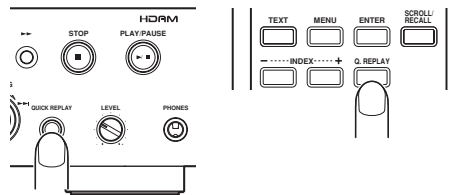

When the QUICK REPLAY button on the player or Q.REPLAY button on the remote control unit is pressed during play, play will be returned by the number of seconds set (factory setting for quick replay time: 10 seconds), and the same section will be played again. With a disc containing MP3 files, it will take some moments for replay to begin.

For details on how to set the quick replay time. (See page 19.)

# ADVANCED OPERATIONS

## REPEAT PLAY (PLAYING THE SAME TRACKS REPEATEDLY)

### PLAYING ALL TRACKS REPEATEDLY (ALL-TRACK REPEAT)

This function repeatedly plays all the tracks. Repeat play is possible even during random play or program play.

Press the REPEAT button on the remote control unit.

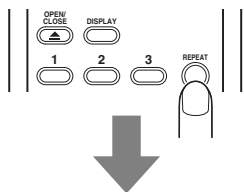

The "RPT" indicator on the display lights, and the repeat play of all the tracks starts.

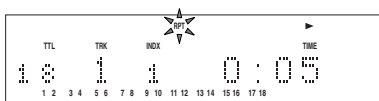

To stop all-track repeat play and resume normal play, press the REPEAT button on the remote control unit twice. The "RPT" indicator on the display goes off. All-track repeat play can also be initiated using EASY JOG on the player. (See page 17.)

### PLAYING ONE TRACK REPEATEDLY (1-TRACK REPEAT)

This function repeatedly plays one track only. Even during random play or program play, it repeats the track being played.

Press the REPEAT button on the remote control unit twice while the track to be repeated is playing.

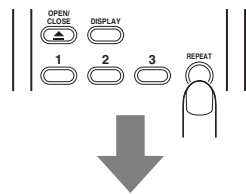

The "RPT" and "1" indicators light, and track now playing is repeated.

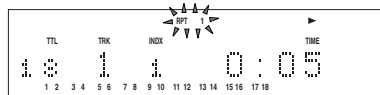

To stop 1-track repeat play and resume normal play, press the REPEAT button on the remote control unit to turn off the "RPT" indicator on the display. 1-track repeat play can also be initiated using EASY JOG on the player. (See page 17.)

### PLAYING A SPECIFIC PART REPEATEDLY (A-B REPEAT)

This function repeatedly plays a specific part of a track that you want to hear.

1. During play, press the A-B button on the remote control unit at the start point of the part to be repeated.

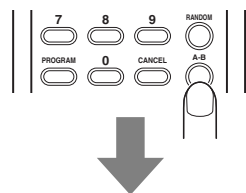

The "A-" indicator on the display now lights.

Display example: A-B repeat, point A (start), track 1, 5 sec.

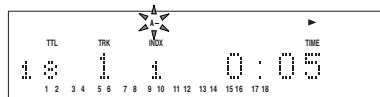

2. Press the A-B button on the remote control unit at the end point of the part to be repeated.

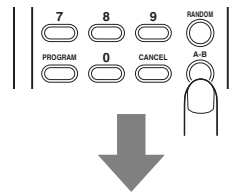

The "A-B" indicator on the display now lights, and the designated part (from point A to point B) is played repeatedly.

Display example: A-B repeat, point B (end), track 1, 20 sec.

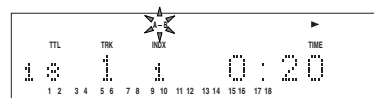

To stop A-B repeat play and resume normal play, press the A-B button on the remote control unit to turn off the "A-B" indicator on the display.

#### Note:

\* The A-B repeat play function cannot be used during random play. Neither can it be used with discs on which MP3 files have been recorded.

## RANDOM PLAY (PLAYING TRACKS IN A RANDOM SEQUENCE)

This function rearranges the tracks into a random sequence and it then plays all the tracks in this random sequence. If it is used together with repeat play, the same tracks can be repeatedly played but in a different sequence every time.

During play or stop, press the RANDOM button on the remote control unit.

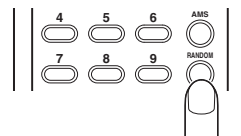

The items on the music calendar appear on the display one after the other, and the "RNDM" indicator lights.

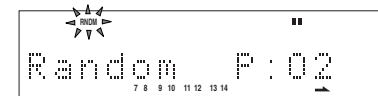

Random play now starts.

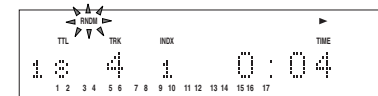

To stop random play and resume normal play, press the RANDOM button on the remote control unit. The "RNDM" indicator on the display goes off. Random play can also be initiated using EASY JOG on the player. (See page 18.)

### SKIPPING TRACKS DURING RANDOM PLAY TO SEARCH OTHER TRACKS

When the ►► button on the remote control unit is pressed or EASY JOG on the player is turned clockwise during random play, the next track is selected at random and played.

Conversely, when the ◀◀ button on the remote control unit is pressed or EASY JOG on the player is turned counterclockwise during random play, play returns to the start of the track now playing. If the same operation is repeated, play is initiated in the reverse order in which the tracks were played.



### AMS PLAY (SEARCHING FOR A SPECIFIC TRACK)

This function comes in handy when searching for a specific track that you want to hear.

During stop or play, press the AMS (auto music scan) button on the remote control unit.

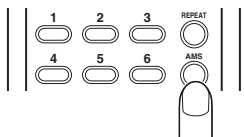

The total number of tracks, track "1" and "SCAN" light on the display, and the "▶" indicator flashes.



are played in succession for the duration which has been set (factory setting: 10 seconds).

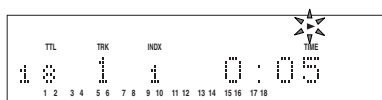

Once the track you want to hear has been found, press the AMS button again. The "▶" indicator now lights, and the track found and whatever comes after that track will now be played normally.

When the RANDOM button on the remote control unit is pressed during AMS play, the AMS play function is released, and the random play mode is established.

AMS play can also be initiated using EASY JOG on the player. (See page 18.)

### PROGRAM PLAY (PLAYING TRACKS IN THE PREFERRED SEQUENCE)

The order in which the CD tracks are played can be rearranged into the sequence desired. Up to 30 tracks can be programmed.

#### PROGRAM PLAY IN THE TIME DISPLAY MODE

In the case of a CD-TEXT disc, first press the TIME button on the remote control unit to set the main display to the time display mode.

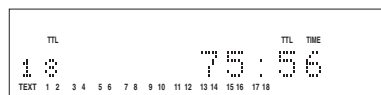
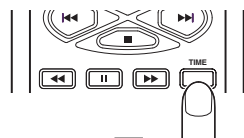

1. During stop, press the PROGRAM button on the remote control unit.

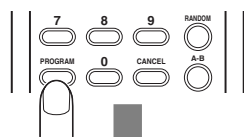

"Program" appears for an instant on the main display.

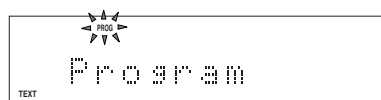

The PROG indicator flashes, and the program mode is established.

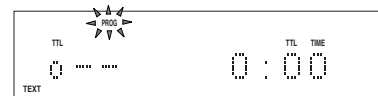

2. Press the numeric buttons on the remote control unit or player that correspond to the track numbers (the tracks can also be selected using the ◀▶ and ▶▶ buttons). To select track number 10 or above, use the numeric buttons to select the higher digit first and then select the lower digit.

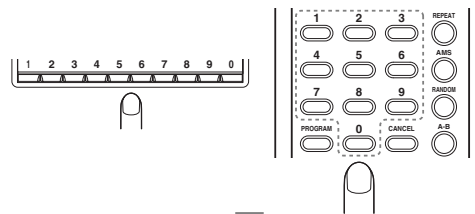

Display example: When track 2 has been selected

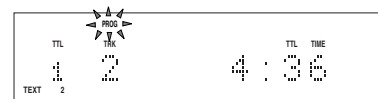

3. Repeat step 2 to program the desired tracks in sequence. At each step of the programming, the number of tracks programmed and their total time appear on the main display. Up to 30 tracks can be programmed.

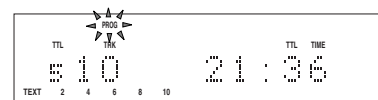

4. Once all the tracks have been programmed, press the ■ button on the player or remote control unit or press the PROGRAM button on the remote control unit.

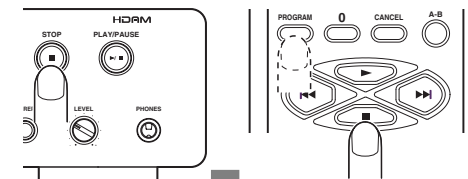

The PROG indicator stops flashing and lights up instead, and the program is entered.

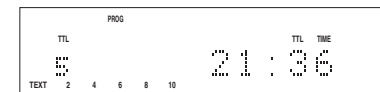

5. Press the ▶/|| button on the player or the ▶ button on the remote control unit. Play now starts in the programmed sequence. Program play will start even when step 4 is omitted. Program play can also be initiated using EASY JOG on the player. (See page 18.)

**Note:**

\* Programming in the text display mode cannot be performed for tracks which have no text information for their titles.

**PROGRAM PLAY IN THE TEXT DISPLAY MODE**

In the case of a CD-TEXT disc, tracks can be selected by title for program play.

If the main display is set to the time display mode, press the TEXT button on the remote control unit to establish the text display mode.

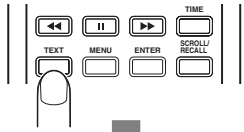

1. During stop, press the PROGRAM button on the remote control unit.

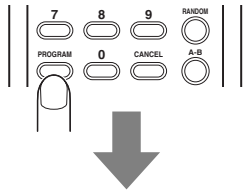

"Program" appears for an instant on the main display. Then the PROG indicator flashes, and the program mode is established.

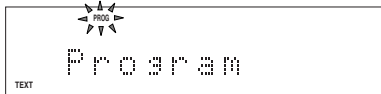

2. Press the ◀◀ and ▶▶ buttons on the remote control unit or use EASY JOG on the player to select the track. (The track can also be selected using the numeric buttons but in this case the title is not displayed).



The title of each selected track is scrolled, and once it has been scrolled, it is programmed automatically. If you do not want to program the track, select another track before the scrolling is completed.



3. Repeat step 2 to program the desired tracks in sequence. Up to 30 tracks can be programmed.
4. Once all the tracks have been programmed, press the ■ button on the player or remote control unit or press the PROGRAM button on the remote control unit.

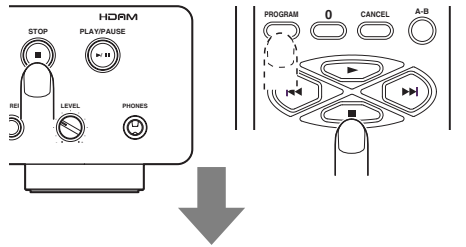

The PROG indicator stops flashing and lights up instead, and the program is entered.



5. Press the ▶/|| button on the player or the ▶ button on the remote control unit. Play of the selected tracks now starts in the programmed sequence. Program play will start even when step 4 is omitted. Program play can also be initiated using EASY JOG on the player. (See page 18.)

**Note:**  
\* Programming in the text display mode cannot be performed for tracks which have no text information for their titles.

**DELETE PROGRAM PLAY (PLAY WITH UNDESIRED TRACKS SKIPPED)**

This function makes it possible to skip those tracks that you do not want to hear during CD play. Up to 30 tracks can be deleted from the program.

**DELETE PROGRAM PLAY IN THE TIME DISPLAY MODE**

In the case of a CD-TEXT disc, first press the TIME button on the remote control unit to set the main display to the time display mode.

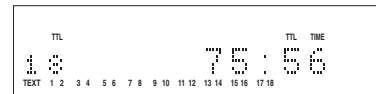
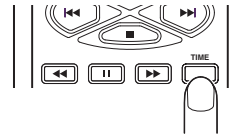

1. During stop, press the PROGRAM button on the remote control unit, and then press the CANCEL button.

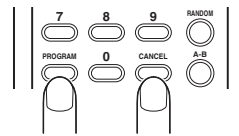

"Delete Prog." appears for an instant on the main display.

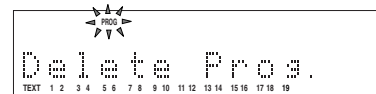

The total number of CD tracks and the total play time appear on the main display, the PROG indicator flashes, and the delete program mode is established.

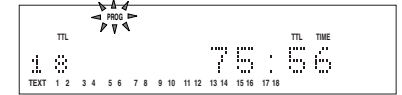

2. Press the numeric buttons on the remote control unit or player that correspond to the track number that you do not want to hear (the track can also be selected using the ◀◀ and ▶▶ buttons).

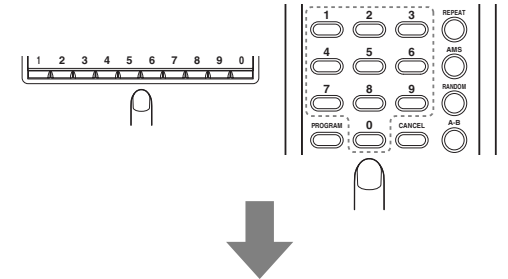

Display example: When track 2 has been selected

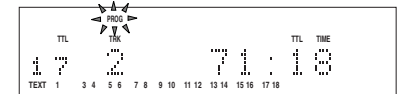

3. Repeat step 2, and upon completion of the programming, press the ■ button on the player or remote control unit or press the PROGRAM button on the remote control unit.

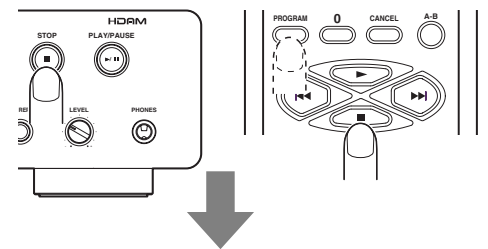

The PROG indicator in the display stops flashing and lights up instead, and the delete program is entered. Up to 30 tracks can be deleted from the program.

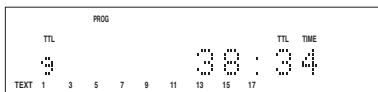

- Press the ►/|| button on the player or the ► button on the remote control unit. The CD is now played but with the deleted tracks skipped. Delete program play can also be initiated using EASY JOG on the player. (See page 18.)

### DELETE PROGRAM PLAY IN THE TEXT DISPLAY MODE

In the case of a CD-TEXT disc, the tracks that are not desired can be selected by title for delete program play.

If the main display is set to the time display mode, press the TEXT button on the remote control unit to establish the text display mode.

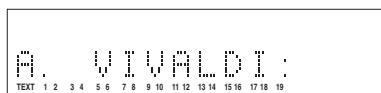
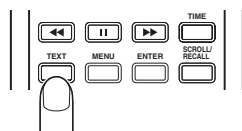

- During stop, press the PROGRAM button on the remote control unit, and then press the CANCEL button.

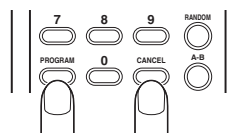

"Delete Prog." appears for an instant on the main display.

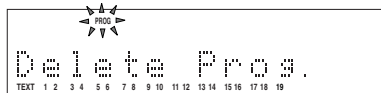

The total number of CD tracks and the album title appear on the main display, the PROG indicator flashes, and the delete program mode is established.

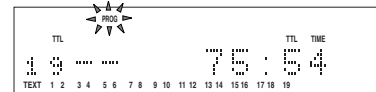

- Press the ◀◀ and ▶▶ buttons on the remote control unit or use EASY JOG on the player to select the track which you do not want to hear. (The tracks can also be selected using the numeric buttons but in this case the titles will not be displayed.)



The title of each selected track is scrolled, and once it has been scrolled, it is deleted automatically. If you do not want to delete the track, select another track before the scrolling is completed.



- Repeat step 2, and upon completion of the programming, press the ■ button on the player or remote control unit or press the PROGRAM button on the remote control unit.

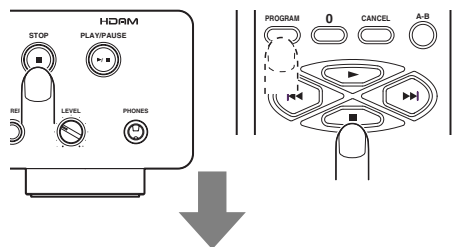

The PROG indicator in the display stops flashing and lights up instead, and the delete program is entered. Up to 30 tracks can be deleted from the program.

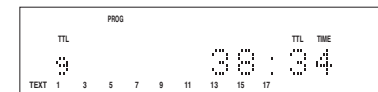

- Press the ►/|| button on the player or the ► button on the remote control unit. The CD is now played but with the deleted tracks skipped. Delete program play can also be initiated using EASY JOG on the player. (See page 18.)

**Note:**

\* Delete programming in the text display mode cannot be performed for tracks which have no text information for their titles.

**CHECKING THE PROGRAM OR DELETE PROGRAM CONTENTS**

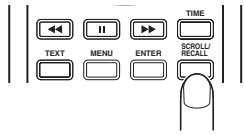

During programming operation or program play, press the SCROLL/RECALL button on the remote control unit.

With program play, the programmed tracks are displayed one after the other in sequence on the main display.

With delete program play, the deleted tracks are displayed one after the other in sequence on the main display.

**CHANGING THE PROGRAM OR DELETE PROGRAM CONTENTS**

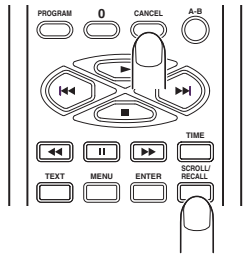

**Deleting tracks which were programmed for program play**

When the SCROLL/RECALL button on the remote control unit is pressed during programming, the programmed tracks are displayed one after the other in sequence.

As soon as the track to be deleted from the program has appeared, press the CANCEL button on the remote control unit immediately. The number of the deleted track is cleared from the music calendar on the display.

**Canceling the deletion of tracks which were deleted for delete program play**

When the SCROLL/RECALL button on the remote control unit is pressed during delete programming, the deleted tracks are displayed one after the other in sequence.

As soon as the track whose deletion is to be canceled has appeared, press the CANCEL button on the remote control unit immediately. The number of the track whose deletion was canceled is displayed in the music calendar on the display.

**RETURNING PROGRAM PLAY TO NORMAL PLAY (CANCELING THE ENTIRE PROGRAM)**

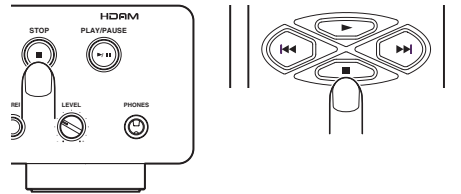

Press the ■ button on the player or remote control unit twice during program play or once during stop. The PROG indicator on the display goes off, and the entire program is canceled.

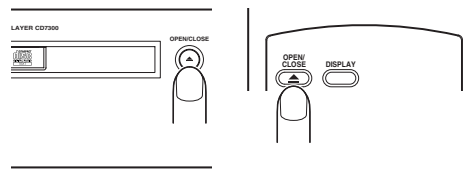

Alternatively, a program can be canceled when the disc tray is opened by pressing the OPEN/CLOSE ▲ button on the player or remote control unit.

**Adding tracks to the program**

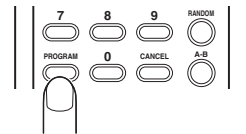

Press the PROGRAM button on the remote control unit during stop. The status of the PROG indicator in the display changes from lighted to flashing, and more tracks can be added to the program.

**PRECAUTIONS FOR PROGRAM AND DELETE PROGRAM PLAY**

- \* The program play and delete program play functions cannot be used with discs on which MP3 files have been recorded.
- \* When using the numeric buttons to select tracks 1 to 9 on a CD with 10 or more tracks in total, allow 1.5 seconds or so to elapse after the button corresponding to the number of the previous track was pressed before pressing the button corresponding to the number of the next track.
- \* When using the numeric buttons to select track 10 or up on a CD with 10 or more tracks in total, press the button corresponding to lower digit within 1.5 seconds or so after the button corresponding to the higher digit was pressed.
- \* When using the ◀◀ and ▶▶ buttons for programming, keep pressing one of these buttons with less than half a second or so in between until the number of the desired track is displayed.
- \* If the total time for a program exceeds 99 minutes, the time display will appear as “-- : --”.

**PITCH CONTROL (CHANGING THE PLAY SPEED)**

The play speed (pitch) can be changed across a ±12% range.

\* Digital signals are not output during pitch control.

**INCREASING THE PLAY SPEED**

Press the PITCH+ button on the remote control unit.

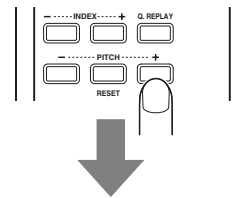

Each time the button is pressed, the play speed is increased in 1% increments (up to a maximum of +12%), and it is displayed on the main display.

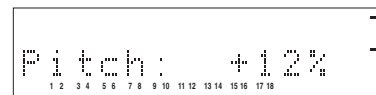

**REDUCING THE PLAY SPEED**

Press the PITCH- button on the remote control unit.

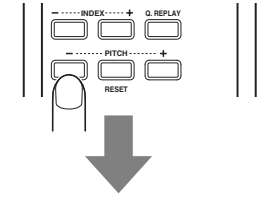

Each time the button is pressed, the play speed is reduced in 1% increments (up to a minimum of -12%), and it is displayed on the main display.

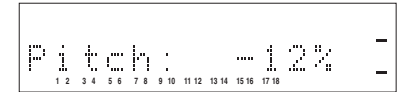

**RETURNING PLAY TO THE NORMAL SPEED (0%)**

Press the PITCH RESET button on the remote control unit.

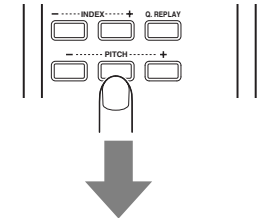

“Pitch: 0%” appears on the main display. If the PITCH RESET button on the remote control unit is pressed again, play returns to the previous speed setting.

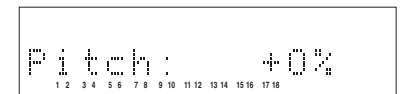

Pitch control can also be performed using EASY JOG on the player. (See page 19.)

# SETTING THE PLAY FUNCTIONS

## USING EASY JOG

The front panel of the player features the EASY JOG dial to facilitate a number of different operations to be performed.

Under normal circumstances, play re-starts at the start of the previous or subsequent tracks by turning the dial clockwise or counterclockwise. The dial also enables the play functions (play modes) to be set from the menu. The menu can also be operated from the remote control unit.

## SETTING THE PLAY FUNCTIONS (PLAY MODES)

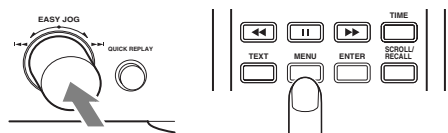

When EASY JOG is pressed or when the MENU button on the remote control unit is pressed, the play function (play mode) setting mode is established.

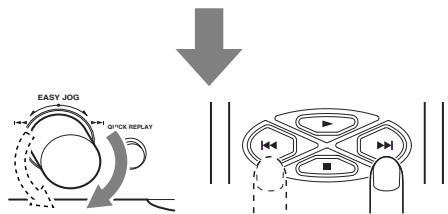

When EASY JOG is turned clockwise or counterclockwise in this mode, the play function menu is switched.

The play function (play mode) menu can also be switched by pressing the MENU button or the  $\lll$  or  $\ggg$  button on the remote control unit.

Shown below is the play function (play mode) menu which is switched when EASY JOG is turned.

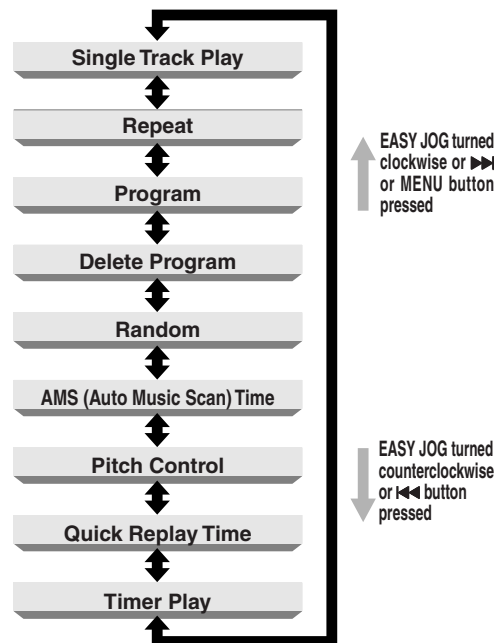

At the desired play function (play mode), either press EASY JOG on the player or press the ENTER button on the remote control unit to select the mode concerned.

For subsequent details on the play functions (play modes), refer to pages 17 to 19.

## VARIOUS PLAY FUNCTIONS (PLAY MODES)

### SINGLE TRACK PLAY (ON/OFF)

This function enables single play searches which come in handy at such times as practicing musical performances or using the player at broadcast facilities.

1. Press EASY JOG and then turn it so that "Single Play" appears on the main display.

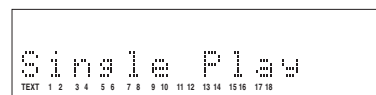

2. Press EASY JOG (or press the ENTER button on the remote control unit) to select Single Track Play.

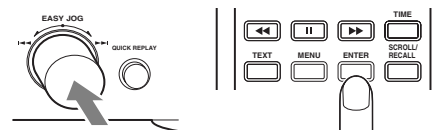

3. Turn EASY JOG (or press the  $\lll$  or  $\ggg$  button on the remote control unit).



"Single:ON" and "Single:OFF" appear alternately on the main display.

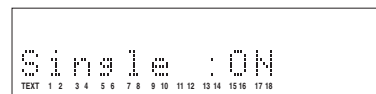

4. With "Single:ON" displayed, press EASY JOG (or press the ENTER button on the remote control unit). Single Track Play mode is now set, and "S.PLAY" lights on the display.

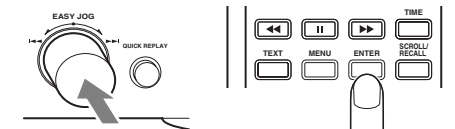

When ON is set, operation stops temporarily at the start of the track, and play stands by. Play is started by pressing the  $\ggg$  button on the player. When the track concerned comes to an end, operation stops temporarily at the start of the next track.

### REPEAT (ALL/1/OFF)

This function enables some or all of the tracks on a disc to be played repeatedly.

1. Press EASY JOG and then turn it so that "Repeat" appears on the main display.

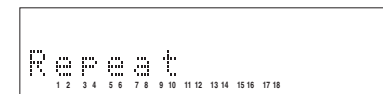

2. Press EASY JOG (or press the ENTER button on the remote control unit) to select Repeat.

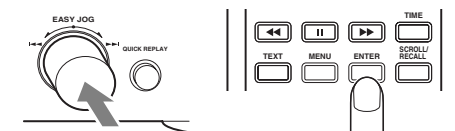

3. Turn EASY JOG (or press the  $\lll$  or  $\ggg$  button on the remote control unit).



The function is switched through three settings: "Repeat:ALL" (all-track repeat) → "Repeat:1" (1-track repeat) → "Repeat:OFF" → "Repeat:ALL."



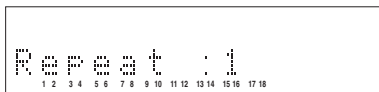
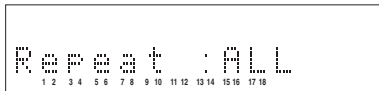

- Press EASY JOG (or press the ENTER button on the remote control unit) to enter the displayed status.

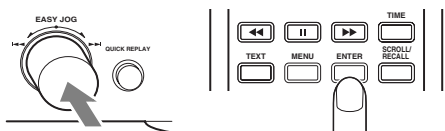

At the "Repeat:ALL" (all-track repeat) setting, all the tracks on the CD are played repeatedly; at the "Repeat:1" (1-track repeat) setting, one track is played repeatedly.

### PROGRAM

This function enables the tracks to be rearranged into the desired sequence for play.

Press EASY JOG and then turn it so that "Program" appears on the main display.

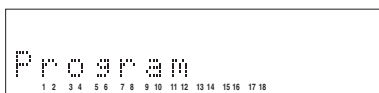

Press EASY JOG (or press the ENTER button on the remote control unit) to select Program.

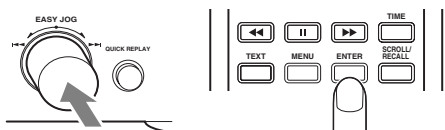

The PROG indicator flashes on the display, and the tracks can be rearranged in the desired sequence. Turning EASY JOG clockwise executes the same function as NEXT ►► (the track number is incremented); conversely, turning it counterclockwise executes the same function as PREVIOUS ◀◀ (the track number is decremented). The program settings are the same as the ones on page 13.

The program function cannot be used with discs on which MP3 files have been recorded.

### DELETE PROGRAM

This function makes it possible to play the CD with the tracks that are not desired skipped.

Press EASY JOG and then turn it so that "Delete Prog." appears on the main display.

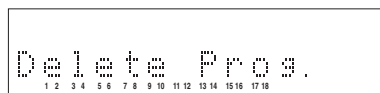

Press EASY JOG (or press the ENTER button on the remote control unit) to select Delete Program.

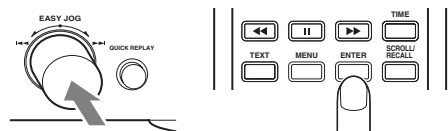

The PROG indicator flashes on the display, the total number of tracks and the total play time are displayed, and the tracks which are not going to be played can be selected.

Turning EASY JOG clockwise executes the same function as NEXT ►► (the track number is incremented); conversely, turning it counterclockwise executes the same function as PREVIOUS ◀◀ (the track number is decremented). The delete program settings are the same as the ones on page 14.

The delete program function cannot be used with discs on which MP3 files have been recorded.

### RANDOM (ON/OFF)

This function enables the tracks to be rearranged in a random sequence and played.

- Press EASY JOG and then turn it so that "Random" appears on the main display.

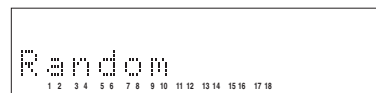

- Press EASY JOG (or press the ENTER button on the remote control unit) to select Random.

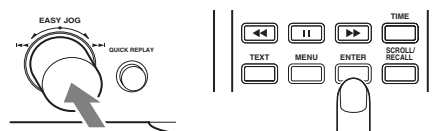

- Turn EASY JOG (or press the ◀◀ or ►► button on the remote control unit).



"Random:ON" and "Random:OFF" appear alternately on the main display.

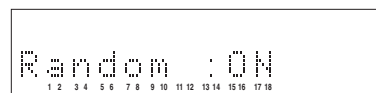

- With "Random:ON" displayed, press EASY JOG (or press the ENTER button on the remote control unit) to enter the setting. "RNDM" indicator lights on the display.

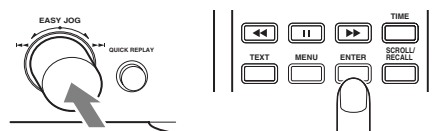

When the disc is played at the "Random:ON" setting, its tracks are all rearranged into a random sequence and played.

### AMS (AUTO MUSIC SCAN) TIME

The AMS function enables the intros of all the tracks starting from track 1 to be played for the duration which has been set one after the other. In the case of this player, it enables the intro play time to be set.

- Press EASY JOG and then turn it so that "AMS Time" appears on the main display.

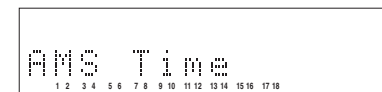

- Press EASY JOG (or press the ENTER button on the remote control unit) to select AMS Time.

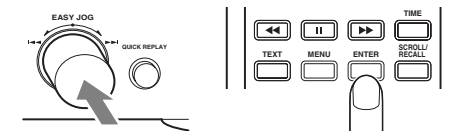

- Turn EASY JOG (or press the ◀◀ or ►► button on the remote control unit).

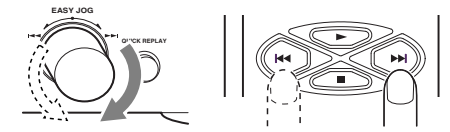

The AMS play time setting now appears on the main display. The factory setting is 10 seconds but this can be increased (to a maximum of 30 seconds) by turning EASY JOG clockwise or reduced (to a minimum of 3 seconds) by turning it counterclockwise.

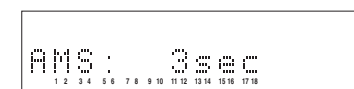

Minimum

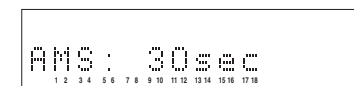

Maximum

- Set the time, and press EASY JOG (or press the ENTER button on the remote control unit) to enter the setting and start AMS play.

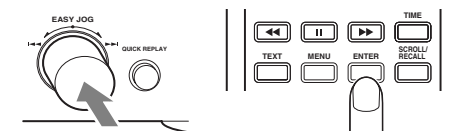



### PITCH CONTROL

This function enables the play speed (pitch) to be adjusted within a +/-12% range. The setting is restored to "0%" when the disc is replaced.

1. Press EASY JOG and then turn it so that "PitchControl" appears on the main display.



2. Press EASY JOG (or press the ENTER button on the remote control unit) to select Pitch Control.

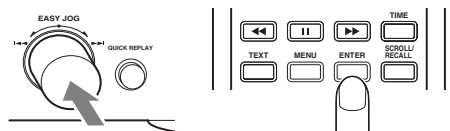

3. Turn EASY JOG (or press the <<< or >>> button on the remote control unit).



The pitch control setting now appears on the main display. The factory setting is ±0% but this can be increased (to a maximum of +12%) by turning EASY JOG clockwise or reduced (to a minimum of -12%) by turning it counterclockwise.

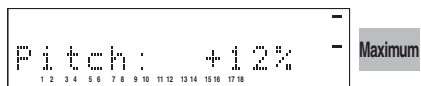
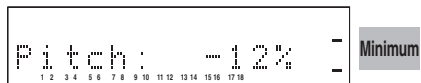

4. Set the play speed (pitch), and press EASY JOG (or press the ENTER button on the remote control unit) to enter the setting.

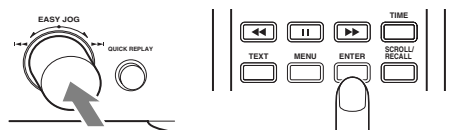

### QUICK REPLAY TIME

This function is used to set the number of seconds for which quick replay is to be performed.

1. Press EASY JOG and then turn it so that "Q.ReplayTime" appears on the main display.

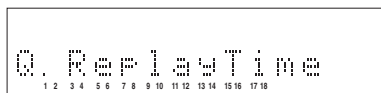

2. Press EASY JOG (or press the ENTER button on the remote control unit) to select Quick Replay Time.

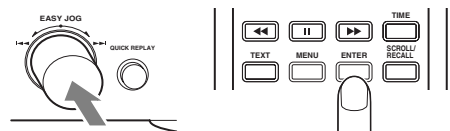

3. Turn EASY JOG (or press the <<< or >>> button on the remote control unit).



The quick replay time setting now appears on the main display. The factory setting is 10 seconds but this can be increased (to a maximum of 30 seconds) by turning EASY JOG clockwise or reduced (to a minimum of 1 second) by turning it counterclockwise.

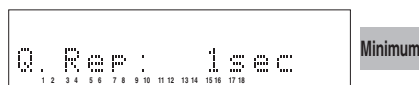

4. Set the quick replay time (number of seconds), and press EASY JOG (or press the ENTER button on the remote control unit) to enter the setting.

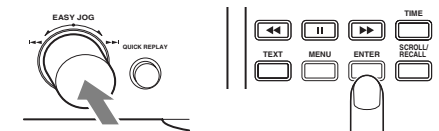
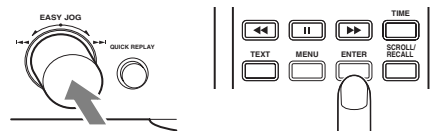

### TIMER PLAY (ON/OFF)

This function uses a timer available on the market to perform timer play operations where play can be started at a designated time.

1. Press EASY JOG and then turn it so that "Timer Play" appears on the main display.

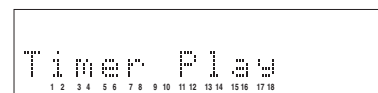

2. Press EASY JOG (or press the ENTER button on the remote control unit) to select Timer Play.

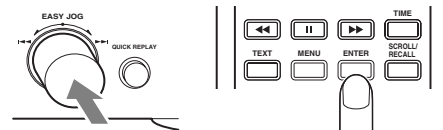

3. Turn EASY JOG (or press the <<< or >>> button on the remote control unit).



"Timer PLY:ON" and "Timer PLY:OFF" appear alternately on the main display.

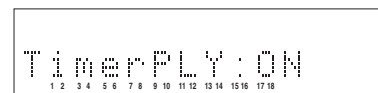

4. With "Timer PLY:ON" displayed, press EASY JOG to enter the setting. "TIMER" indicator lights on the display.

# OTHER FUNCTIONS

## LAST MEMORY

This function stores the play function settings even after the power has been turned off. The settings that can be stored include "AMS Time," "Quick Replay Time" and "Timer Play."

## CD-TEXT

"CD-TEXT" refers to a new kind of music disc which differs from a conventional music disc in that album titles, track titles and other text information are recorded on it. CDs with the following logos support this function.



The text information is recorded on those parts which were not used by conventional music CDs.

This means that discs with recorded CD-TEXT can be played in the same way as in the past on existing CD players but the text information can be viewed only when they are played on a player that supports CD-TEXT.

This player automatically identifies whether a disc supports CD-TEXT, and it displays the information on the display.

Display of player

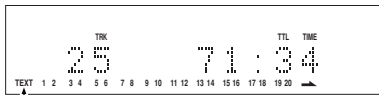

This lights when the disc that has been read is identified as supporting CD-TEXT.

The following items of the text information on CD-TEXT discs can be displayed in sequence by pressing the TEXT button on the remote control unit. However, the recorded information differs from one disc to another so that not all the information given below will necessarily be displayed. Items not recorded are automatically omitted and skipped by the player, and only the existing items are displayed.

## DURING PLAY

Each time the TEXT button on the remote control unit is pressed, the information items are displayed in the following sequence. During play, the information of track now playing is mainly displayed.

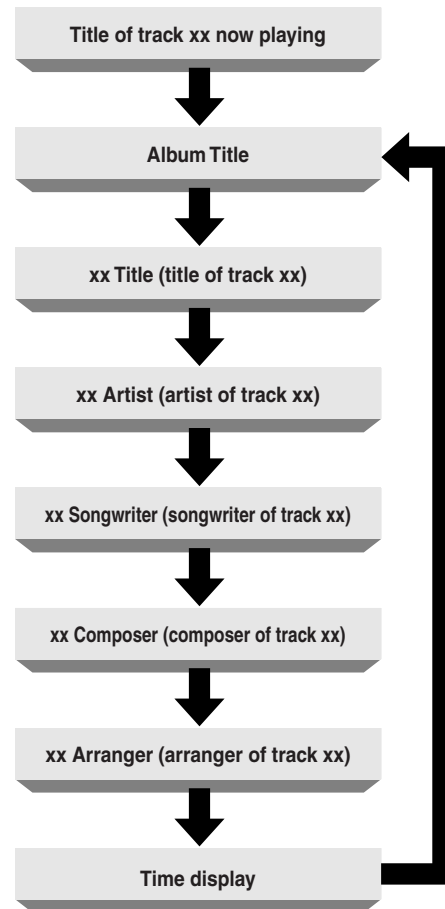

## IN THE STOP MODE

Each time the TEXT button on the remote control unit is pressed, the information items are displayed in the following sequence. When the ► button is pressed while "-- Title" is displayed, the track concerned starts playing. The maximum of characters that can be displayed is 64.

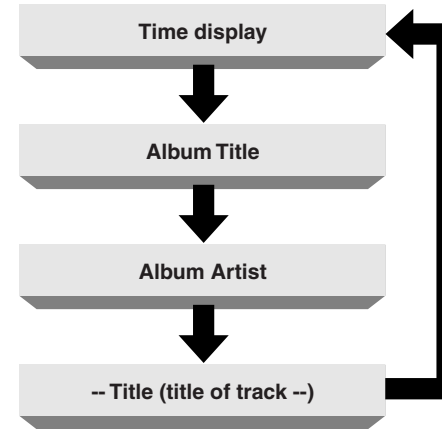

## CR-R/CD-RW DISC PLAY

In addition to conventional music CDs and CD-R (recordable) discs, this player can also play CD-RW (rewritable) discs. It also supports the unfinalized discs that cannot be played by regular CD players.

## PLAYING UNFINALIZED CD-R/CD-RW DISCS

CD players normally play only those discs on which the TOC information (\*) has been recorded. This means that in order for a CD player to play a CD-R/CD-RW disc with music recordings, the disc had to be "finalized" by writing the TOC information onto it. Discs for which this finalizing job has not been done are called unfinalized discs, and this player is designed to support the play of these unfinalized discs as well.

Consequently, even CD-R/CD-RW discs on which more material is to be recorded can be enjoyed without further ado using this player.

\* "TOC" stands for the table of contents which contains the total number of tracks, the total play time and other such information on the disc. This information has been recorded on the inner circumference area of the disc.

## PRECAUTIONS FOR UNFINALIZED CD-R/CD-RW DISCS

Take care not to scratch or dirty the area near the innermost circumference of unfinalized CD-R/CD-RW discs. Scratches, dirt or other abnormalities in this area may make it impossible for the disc to be read.

On unfinalized CD-R/CD-RW discs recorded using a CD recorder for audio applications, provisional TOC information is recorded in the PMA area (\*) which is further inside from the TOC information area. This player supports unfinalized discs by reading the information in the PMA area, but because this area is extremely narrow, any scratches, dirt or other abnormalities here may make it impossible for discs to be read.

On some discs, this area may be very difficult to read. In cases like this, use the disc after using a CD recorder to do the finalizing. It is recommended that the finalizing be done before scratches or dirt makes it hard for the discs to be read.

\* "PMA" stands for program memory area, and it refers to the area where the provisional contents information such as the number of tracks and play times recorded on the CD-R/CD-RW discs is recorded. Discs cannot be played by this player unless the PMA has been recorded properly.

\* This player supports the discs which have been recorded by any recorder that complies with the "Orange Book" of CD-R/CD-RW standards.

\* The player can play only those discs recorded in the music format (CD-DA) or using MP3 files.

\* If there is not much recording time, it may be difficult for the data to be read out, and it may cause error.

\* When the player is to play a CD-RW disc or unfinalized CD-R/CD-RW disc, it automatically recognizes the type of disc, and changes some of its internal settings to suit the disc concerned. For this reason, the disc reading process will take a little longer compared with regular music CDs or CD-R discs.

## MP3

This player can play CD-R/CD-RW discs as well as discs available on the market recorded using MP3 files (\*).

The ID3 tag (\*) is supported by this player. The album title, track title and name of the artist can be displayed for the track (file) on which the ID3 tag information has been recorded.

\* "MP3" refers to music data which has been compressed by a file format known as "MPEG-1 Audio Layer 3." Files with the ".mp3" or ".MP3" extension are called MP3 files.

\* "ID3 tag" refers to a format which adds the album title, track titles, names of the artists and other text information to the MP3 files.

### MP3 FILE PLAYBACK

#### Playing albums in sequence

1. As with a music CD, place the disc recorded using the MP3 files on the disc tray, and retract the disc tray.
2. Press the ►/|| button on the player or the ► button on the remote control unit.  
Play now starts in sequence from the first album (on a folder by folder basis (\*)). (See next section.)

\* With a disc recorded with MP3 files, it takes about 40 seconds after the player's power has been turned on for the player's system to be switched before initial play.

#### Selecting and playing albums (folders)

Select the desired album (on a folder by folder basis (\*)) using the ►► or ◀◀ button on the player or remote control unit. Play now starts in sequence from the selected album. The album number appears on the display.  
(AL xxx)

#### DISPLAYING THE ID3 TAG INFORMATION

The following display appears when the TEXT button on the remote control unit is pressed while playing an MP3 file disc on which the ID3 tag information has been recorded.

#### During play

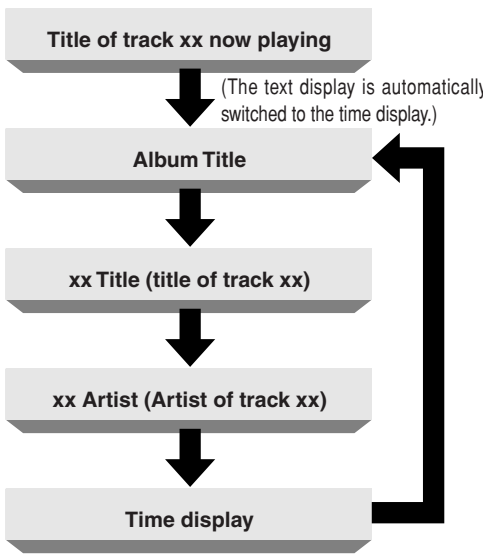

\* Those items among the display information which were not recorded are skipped, and only the recorded items are displayed.

#### During stop

The ID3 tag information is not displayed during stop.

#### PRECAUTIONS FOR DISCS RECORDED USING MP3 FILES

- \* The format of the files played have the ".mp3" or ".MP3" extension. Files with any other extension cannot be played.
- \* The Joliet file system, an extension to the ISO9660 file format, is supported as the write format. Both mode 1 (CD-ROM) and mode 2 (CD-ROM XA) are supported. MP3 file discs recorded using packet writing cannot be played.
- \* The supported MP3 file sampling frequency is 44.1 kHz and the bit rate is 128 kbps. The sound may be interrupted when playing files with any other sampling frequency and bit rate.
- \* The maximum number of characters in the ID3 tag information that can be displayed by this player is 32. Characters other than alphanumeric will not be displayed properly. Japanese characters cannot be displayed.

- \* Digital signals are not output from the player while playing discs recorded using MP3 files.
- \* It may not be possible for CD-R/CD-RW discs on which MP3 files were recorded to be played properly depending on the environment of the personal computer used to record the files, the writing software program and the CD-R/CD-RW discs concerned. Check the external components used.
- \* MP3 files on mixed CDs or enhanced CDs containing a mixture of the CD-DA format for music purposes and MP3 files cannot be played. Only the CD-DA format for music purposes will be played.
- \* This player also supports discs created by multisessions.
- \* It is recommended that the maximum number of sessions on a CD-R or CD-RW disc be 10, the maximum number of albums for all sessions be 20 and the maximum number of files be 200.

#### FUNCTIONS NOT SUPPORTED BY MP3 PLAY

The following functions are not supported when the player is to play discs recorded with MP3 files.

- A-B repeat
- Program play
- Delete program play
- Index skip

#### CONCERNING RANDOM PLAY

Random play proceeds on an album by album (folder by folder) basis. When all the tracks of the album currently playing have been played, play moves on to the next album in the sequence. During random play, the 1-track repeat and A-B repeat functions cannot be used.

#### EXAMPLE OF PLAY SEQUENCE

##### Diagram showing sequence as displayed by Windows Explorer

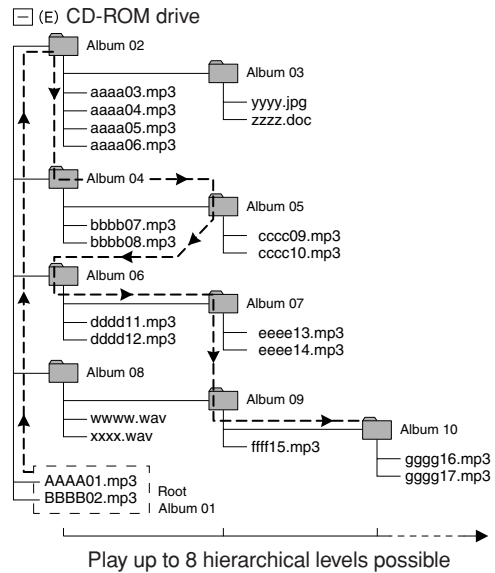

#### Display that appears when the disc shown above is inserted (in the stop mode)

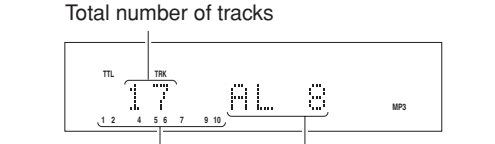

- The dotted line with arrow (· → ·) indicates the sequence in which the MP3 albums and tracks are played.
- Album 01 to album 10  
In the example shown in the figure, this CD-ROM has 10 albums (folders) but albums 03 and 08 are not MP3 files and so cannot be played.
- AAAA01.mp3 to gggg17.mp3  
In the example shown in the figure, this CD-ROM has 17 tracks starting with track "01" and ending with track "17."
- Only those files with the ".mp3" extension are played; all other files with the .wav, .jpg, .doc and other extensions are skipped.
- Album 01 is allocated even when there are no files in the root.
- The sequence may differ from the one that appears on the personal computer. It may also differ depending on the writing software program.

# SPECIFICATIONS AND DIMENSIONS

## SPECIFICATIONS

### Audio characteristics

Channels .....	2 channels
Frequency response .....	2 Hz to 20 kHz
Dynamic range .....	100 dB
Signal-to-noise ratio .....	110 dB
Channel separation .....	100 dB (1 kHz)
Harmonic distortion .....	0.0025% (1 kHz)
Wow & flutter .....	Precision of quartz
Error correction system .....	Cross-interleave Reed Solomon code (CIRC)
Audio output .....	2.0 V rms, stereo
Headphone output .....	18 mW/32 ohms (variable maximum)
Digital output	
Coaxial output (pin jack) .....	0.5 Vp-p, 75 ohms
Optical output (square optical connector) .....	-19 dBm

### Optical readout system

Laser .....	AlGaAs semiconductor
Wavelength .....	780 nm

### Signal system

Sampling frequency .....	44.1 kHz
Quantization .....	16-bit linear/channel

### Power supply

N version .....	AC 230 V 50 Hz
Power consumption .....	12 W

### Cabinet, etc.

Maximum dimensions .....	440(W) x 89(H) x 317 (D) mm
Weight .....	5.7 kg
Allowable operating temperature .....	+5 to +35°C
Allowable operating humidity .....	5 to 90% (no condensation)

This player's specifications and exterior are subject to change without notice for improvements.

## DIMENSIONS (UNIT: mm)

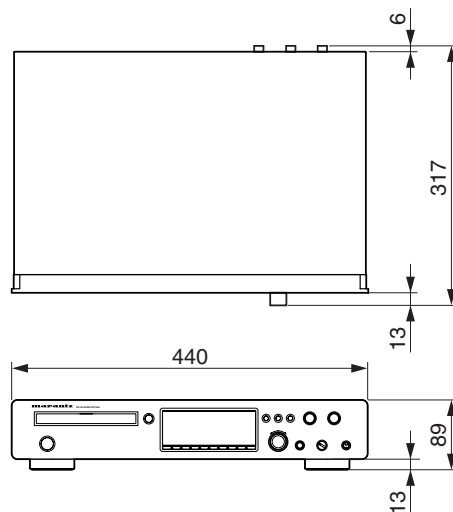

## TROUBLESHOOTING

If you think that something is wrong with your player, first check the points listed below. Incorrect operations can sometimes be taken for trouble and malfunctions. If the trouble persists even after the following points have been checked, consult your dealer or nearest Marantz sales office or service center.

### Disc fails to turn.

- Has the power cord been connected properly?
- Has the player's power been turned on?
- Has the disc been placed in the proper position?
- Is the disc upside down? (Is the disc's label surface facing up?)
- Is the disc dirty?
- Is the disc scratched?
- Is the disc warped?

### Disc turns but no sound is heard.

- Have the amplifier and speakers been connected properly?
- Has the amplifier's power been turned on?
- Has the amplifier's function or selector switch been set to "CD" or "AUX" (or to whichever connectors the player has been connected)?
- Is the amplifier's volume at its lowest setting?

### Disc starts turning but then stops at some point.

- Is the disc dirty?
- Is the disc scratched?
- Is the disc warped?
- Is the disc being played a music CD? CD-ROMs (except their MP3 files) for personal computers, etc. cannot be played.

### No remote control operations.

- Is the transmitter of the remote control unit (RC7300CD) pointed at the remote sensor of the player? Is there anything between the player and remote control unit which is blocking the signals?
- Have the batteries of the remote control unit (RC7300CD) run down?
- Is a strong light shining on the remote sensor of the player?
- Is the REMOTE CONTROL switch on the rear panel set to the EXTERNAL position? (Set it to the INTERNAL position if the player is to be used on its own.)

### CD-R/CD-RW discs cannot be played.

- Has the disc been placed upside down on the disc tray?
- Is the recorded information in a format (CD-DA or MP3) used for music applications?

**www.marantz.com**

You can find your nearest authorized distributor or dealer on our website.

---

<b>JAPAN</b>	Marantz Japan, Inc.	35-1 Sagami Ohno 7-Chome, Sagamihara-shi, Kanagawa 228-8505, Japan
<b>U.S.A.</b>	Marantz America, Inc.	1100 Maplewood Drive, Itasca, IL 60143, U.S.A.
<b>EUROPE</b>	Marantz Europe B.V.	P.O. Box 8744, 5605 LS Eindhoven, The Netherlands

---

**marantz**<sup>®</sup> is a registered trademark.

